



Dinam LED Limited, Dynamic lighting for colorful life

PRODUCTS SPECIFICATION

5050 SMD RIGID BAR SERIES

For DN-R50502312W72-12V



Dinam LED Limited

Web: www.dinamled.com

Email: info@dinamled.com

Contact: Luisa

Tel: +86-755-23063529

Fax: +86-755-22700020

Mobile: +86-13600151478

Mobile: +86-13560459594

Address: B Building, Chuangfu Industrial Zone, Beihuan Road,
Shiyan Town, Baoan District, Shenzhen, China.

72LED Rigid bar Introduction

Features:

Available in 12V DC maximum.

Very bright & low power consumption.

Operating temperature: -20~50°C.

Long life span LED lights, more than 50,000 hours +.

Dimmable to 6V DC.

Water-proof, IP65.

Photos:



Assembly drawing

Top View

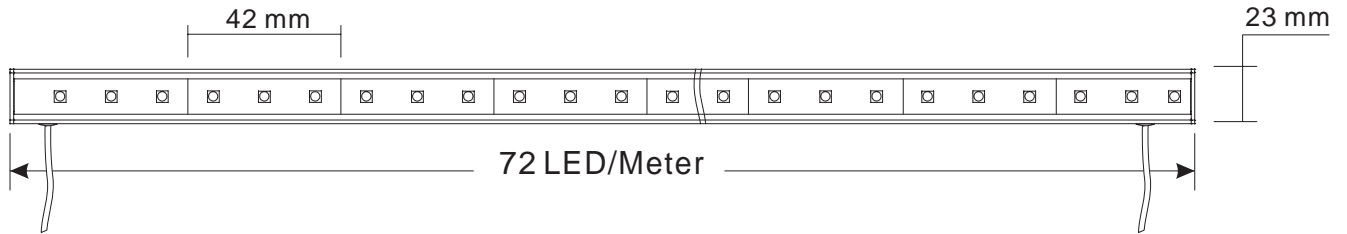

Section

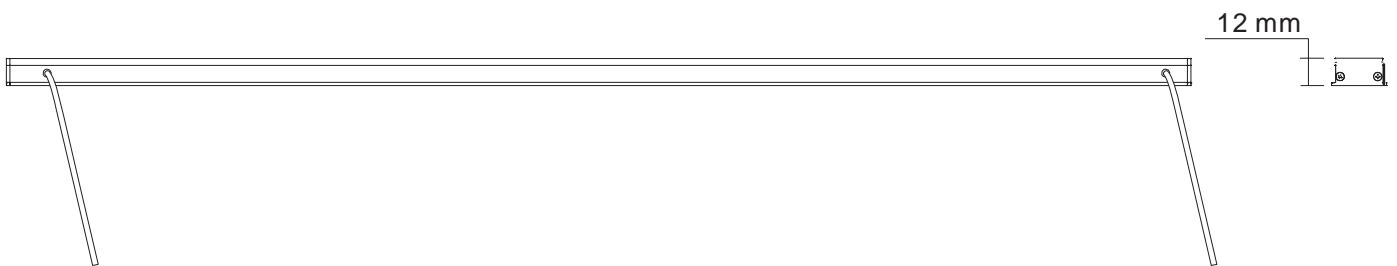

3D View

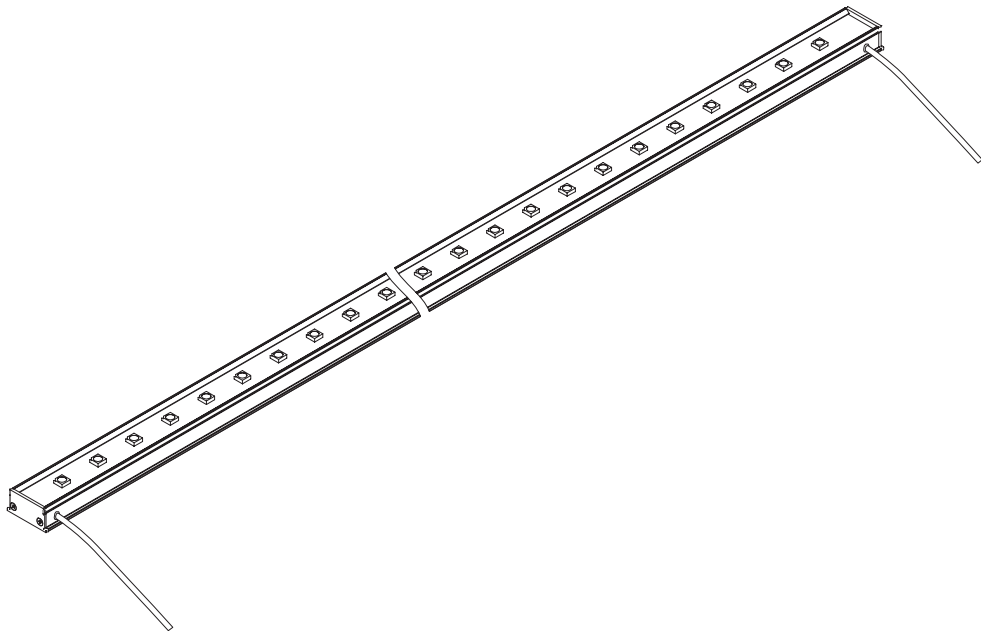

View Angle: 120 degrees

Operation Temperature: -20~50°C

Store Temperature: -30~80°C

5050 Rigid bar: 72 LED/Meter

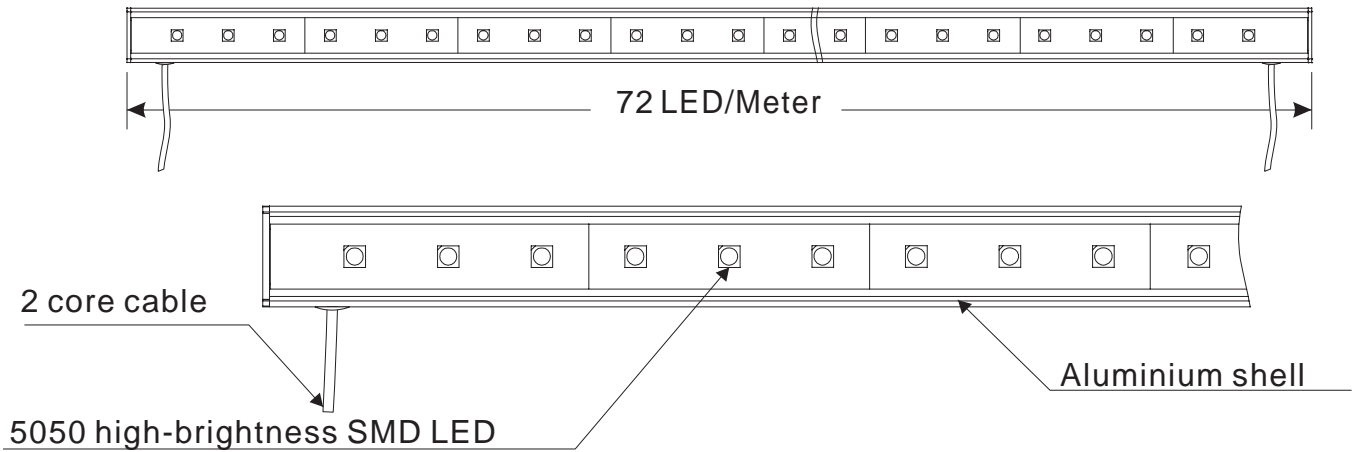

These strips are widely used in shop and bar illumination, it works at 12DC, with super bright SMD LEDs, wide view angle, compact size, easy to install, Aluminium PCB holder help you to fix easily. Water-proof, long life span(more than 50000 hours).

Aluminium series: 5050 72 LED/meter						
Part number	Color	Size	LED QTY/meter	Lumen/meter	Voltage	Power/meter
DN-R50502312R72-12V	Red	42 mm	72	432	DC 12V	17.28 watt
DN-R50502312Y72-12V	Yellow			432		
DN-R50502312B72-12V	Blue			540		
DN-R50502312G72-12V	Green			864		
DN-R50502312W72-12V	White			720~1152		
DN-R50502312WW72-12V	Warm w hite			576~86		
DN-R50502312P72-12V	Pink			432		

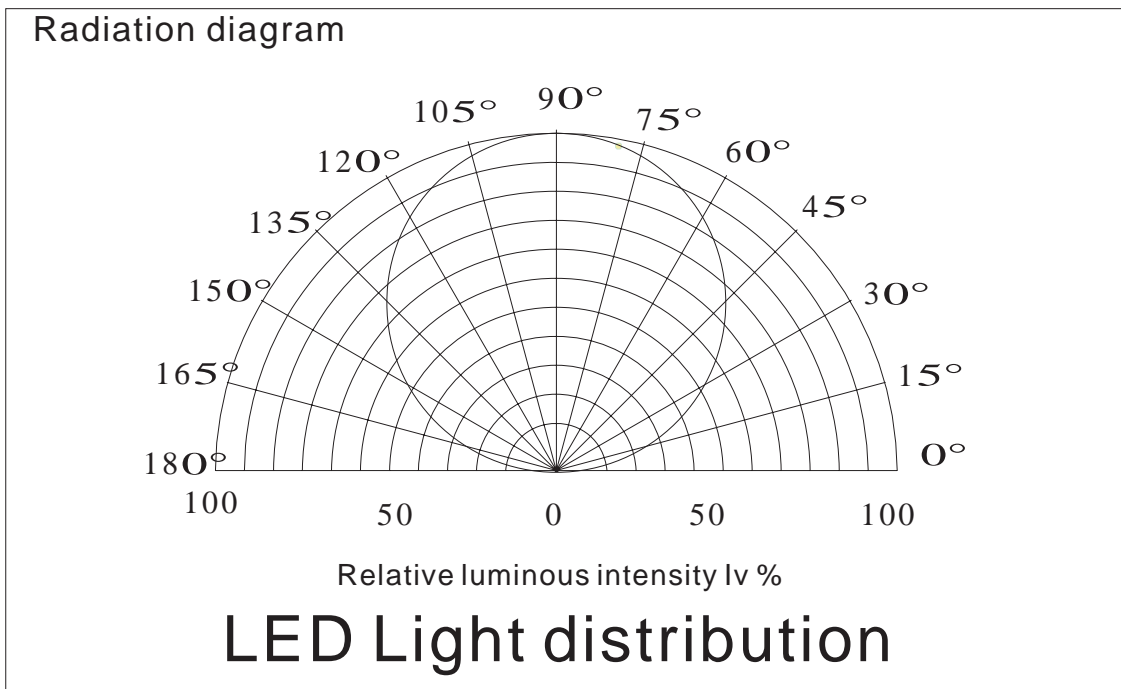

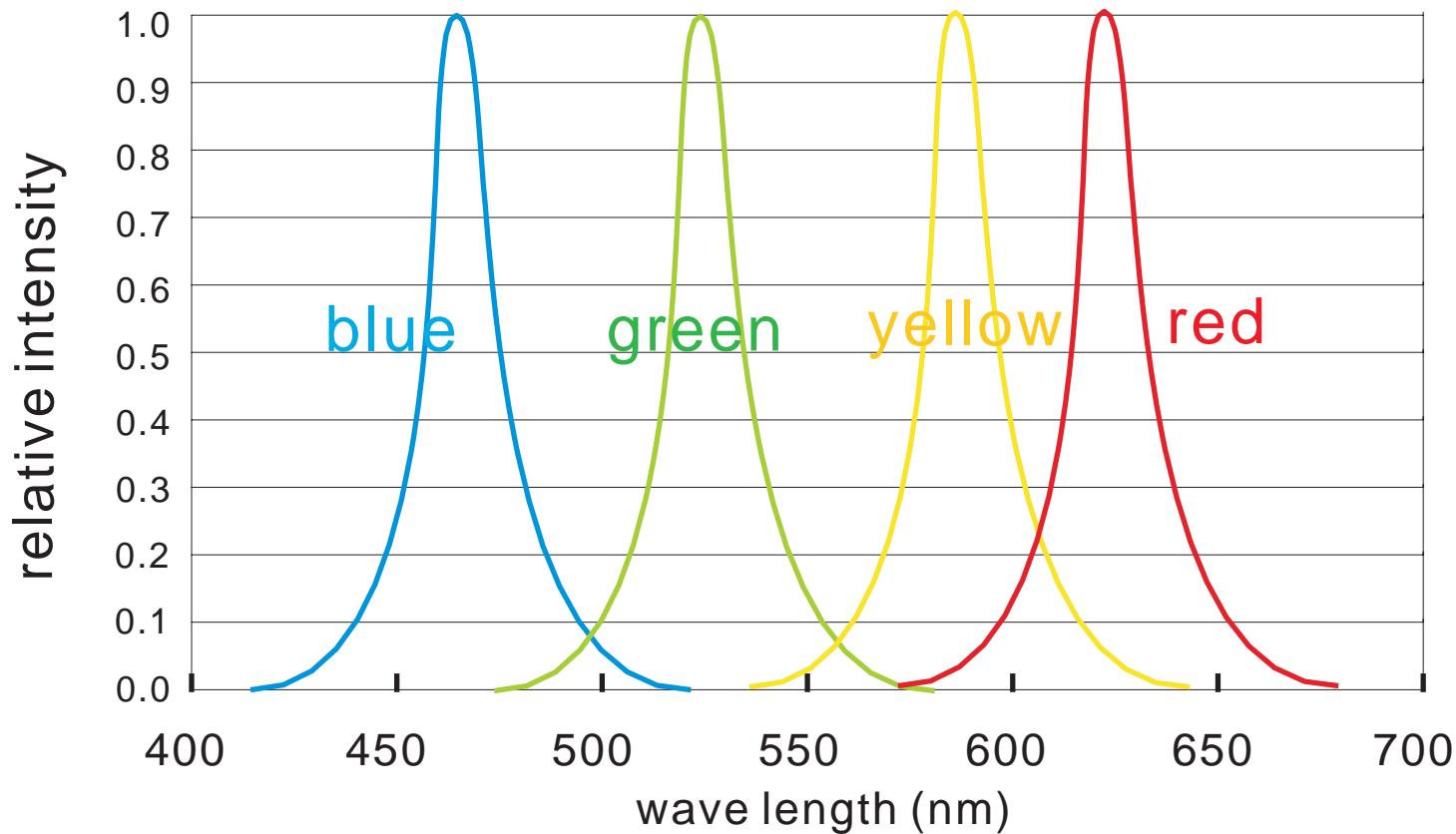

for: red, blue, green, yellow

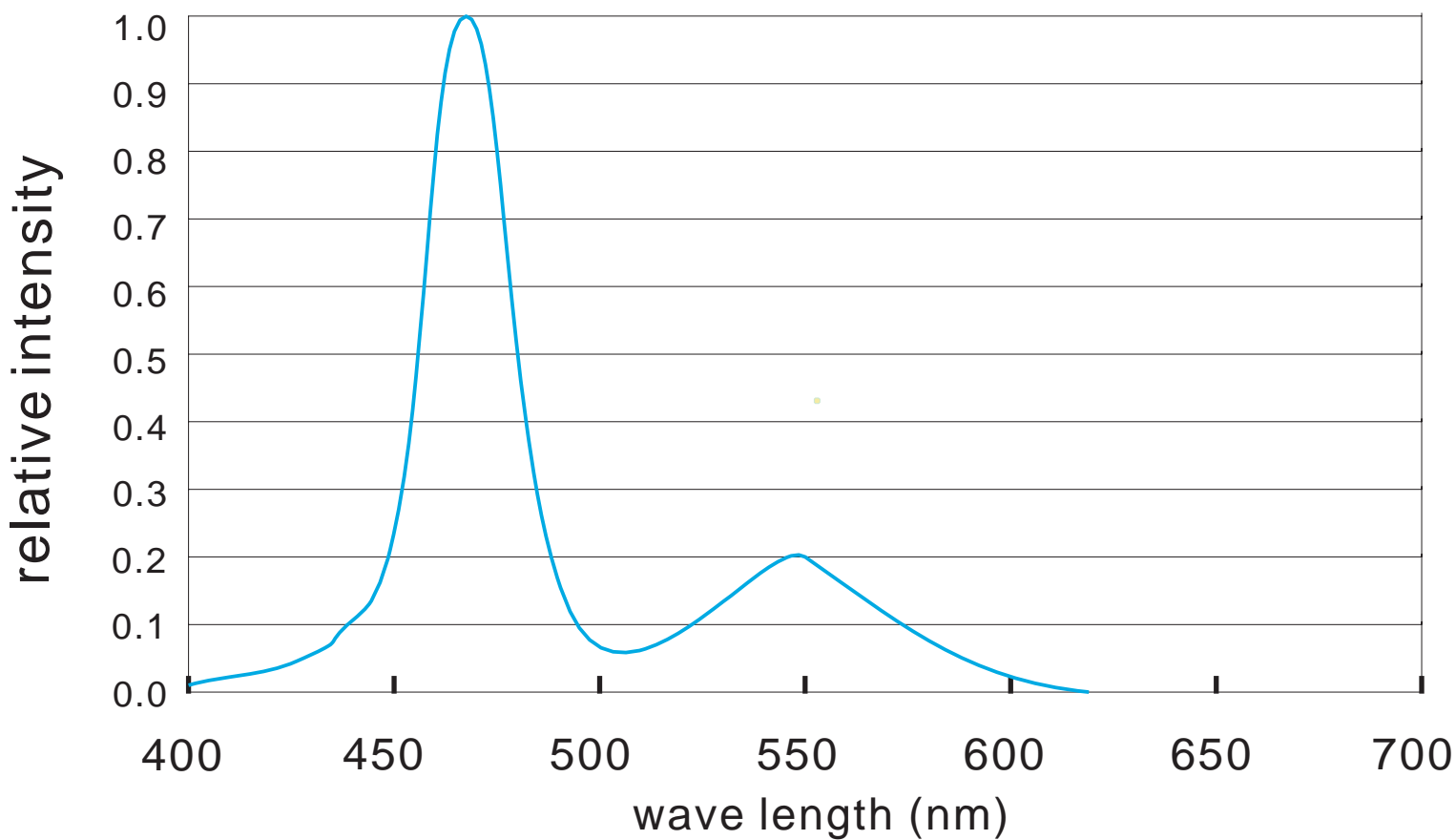

for: white LED

How to connect single color rigid bar

Below shows you how to connect the single color rigid bar to power supplies.

