



Dinam LED Limited, Dynamic lighting for colorful life

PRODUCTS SPECIFICATION

5050 SMD RIGID BAR SERIES

For DN-R50501708W60-12V-A
DN-R50501708W60-12V-B



Dinam LED Limited

Web: www.dinamled.com

Email: info@dinamled.com

Contact: Luisa

Tel: +86-755-23063529

Fax: +86-755-22700020

Mobile: +86-13600151478

Mobile: +86-13560459594

Address: B Building, Chuangfu Industrial Zone, Beihuan Road,
Shiyan Town, Baoan District, Shenzhen, China.

60LED Rigid bar Introduction

Features:

Available in 12V DC maximum.

Very bright & low power consumption.

Operating temperature: -20~50°C.

Long life span LED lights, more than 50,000 hours +.

With Transparent PC cover or Milky white PC cover

Water-proof, IP20.

Photos (Transparent PC cover): [DN-R50501708W60-12V-A](#)

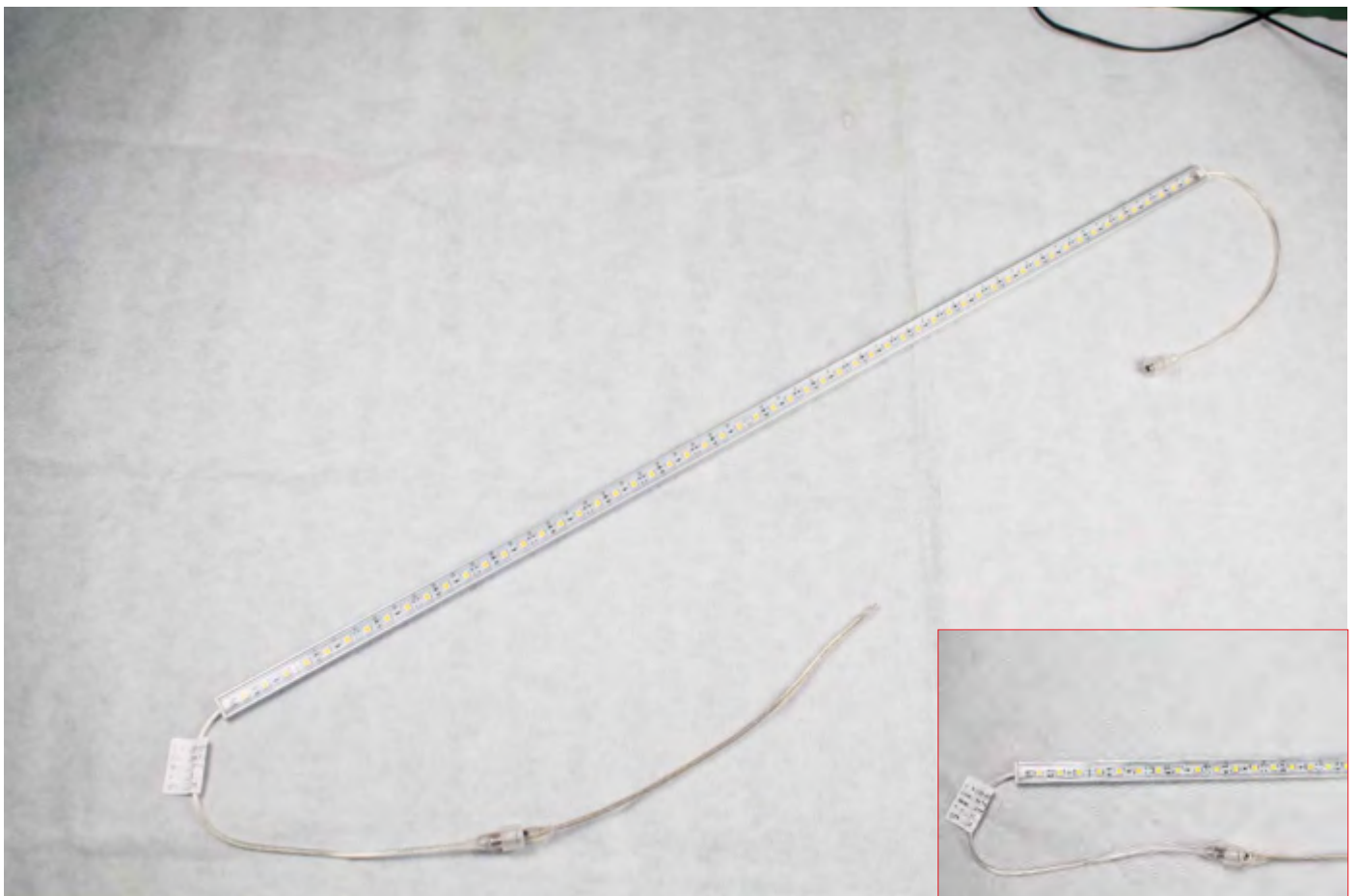

Photos (Milky white PC cover): DN-R50501708W60-12V-B

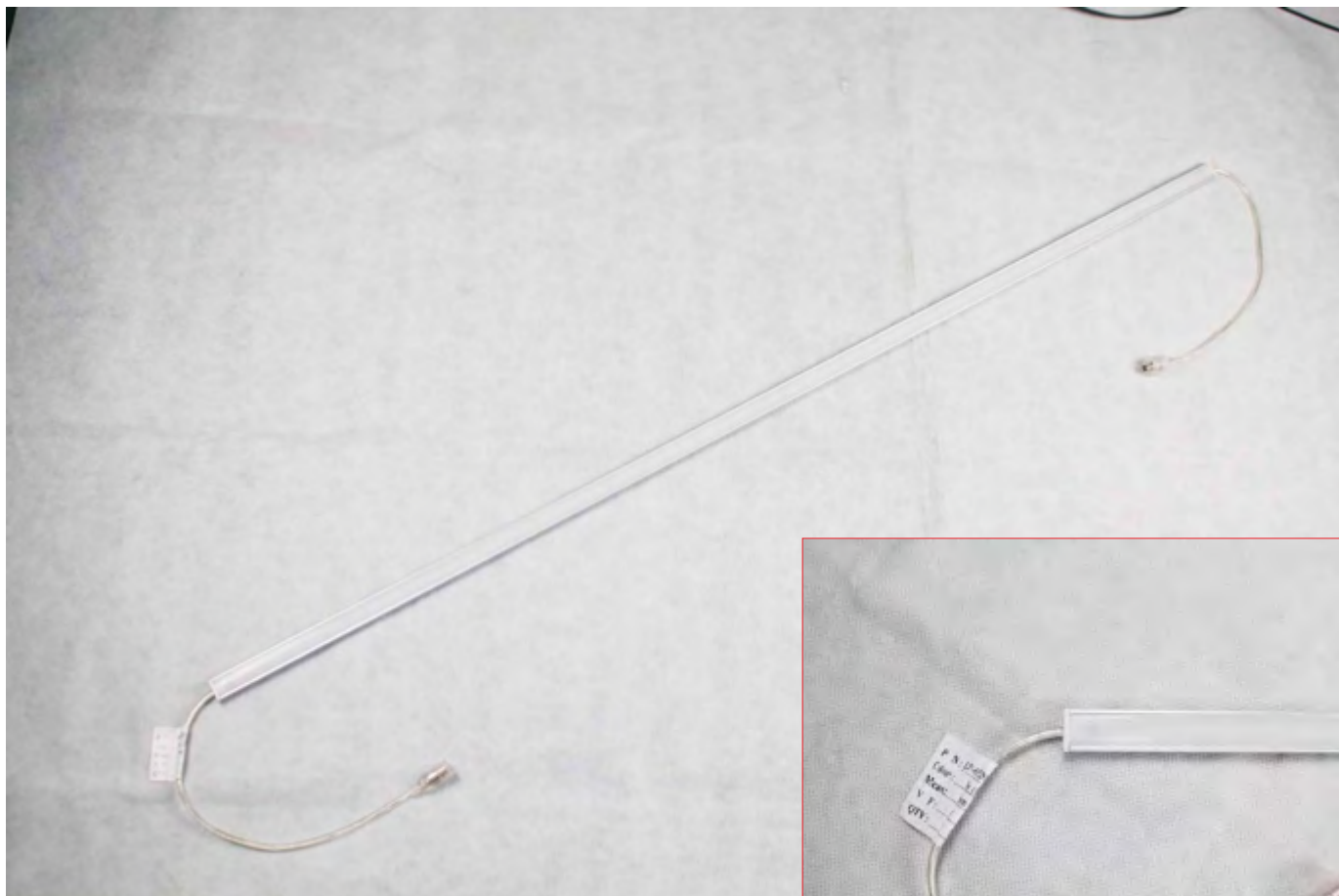

Assembly drawing

Top View

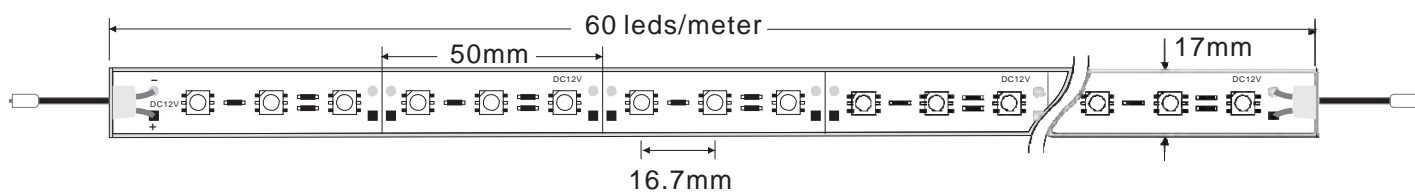

Section







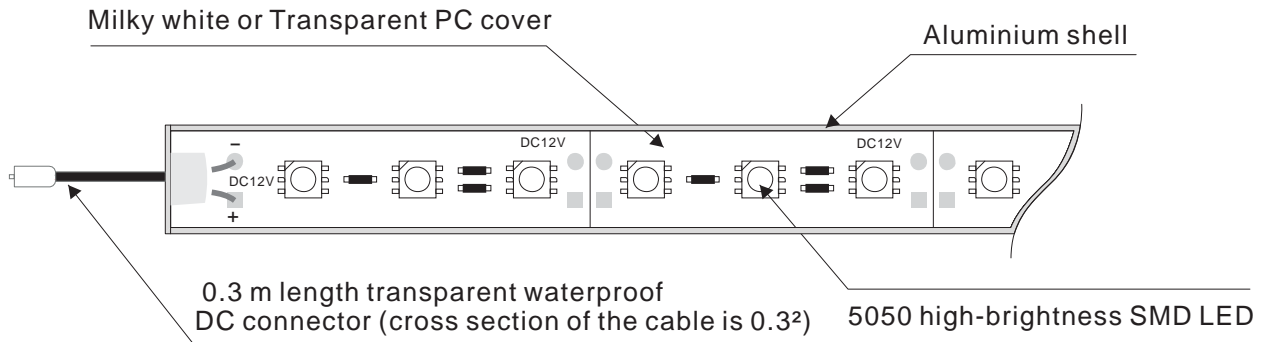
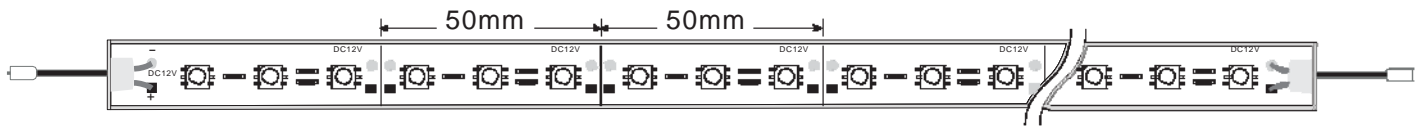





View Angle:120degrees
 Operation Temperature:-20~50°C
 Store Temperature:-30~80°C

5050 Rigid bar: 60 LED/Meter:



These strips are widely used in shop and bar illumination, it works at 12V DC, with super bright SMD LEDs, wide view angle, compact size, easy to install, Aluminium PCB holder help you to fix easily. long life span(more than 50000 hours)

Aluminium series: 5050 60 LED/meter					
Part number	Color	LED QTY/meter	Lumen/meter	Voltage	Power/meter
DN-R50501708RGB60-12V-A/B	Red 	60	120	DC12V	MAX14.4 W
	Green 		240		
	Blue 		150		
DN-R50501708R60-12V-A/B	Red 	60	360	DC12V	MAX14.4 W
DN-R50501708Y60-12V-A/B	Yellow 		360		
DN-R50501708B60-12V-A/B	Blue 		450		
DN-R50501708G60-12V-A/B	Green 		720		
DN-R50501708W60-12V-A/B	White 		600-960		
DN-R50501708WW60-12V-A/B	Warm w hite 		480-720		
DN-R50501708P60-12V-A/B	Pink 		360		

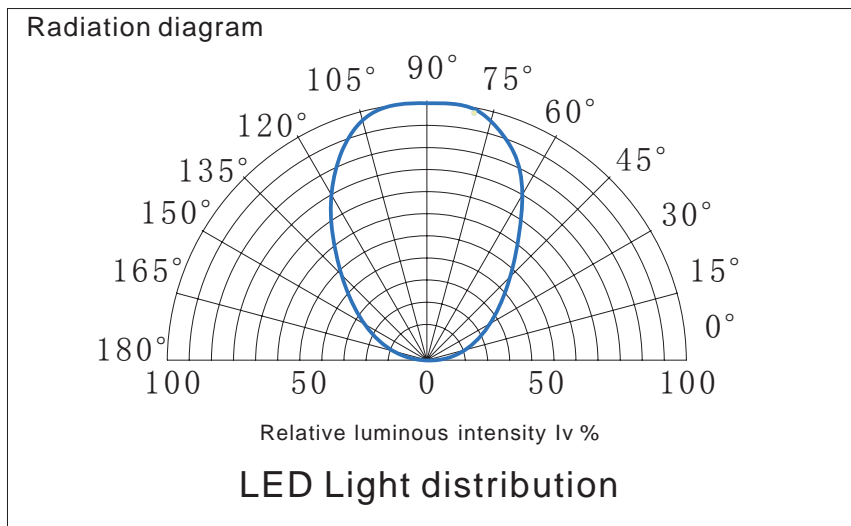

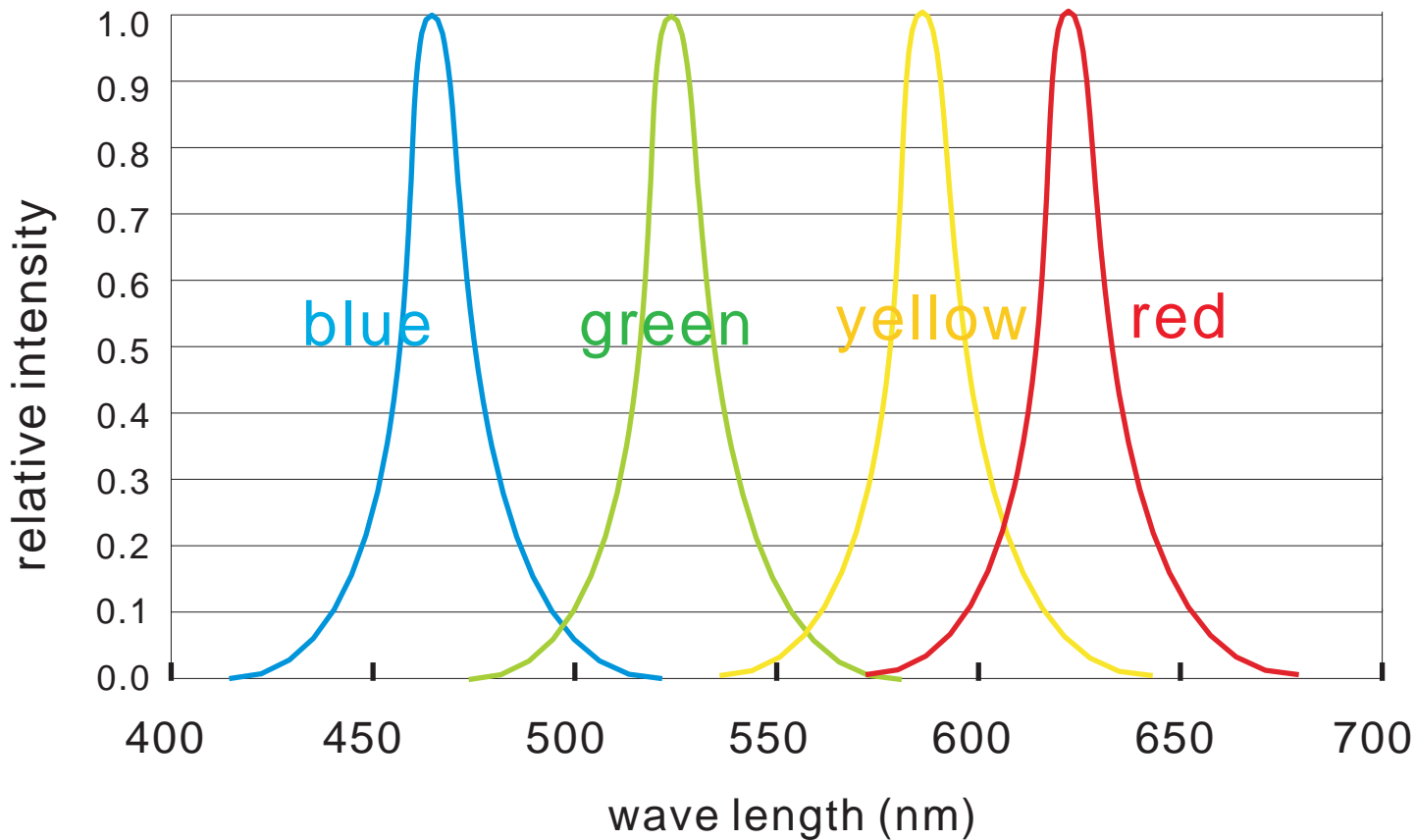

for: red, blue, green, yellow

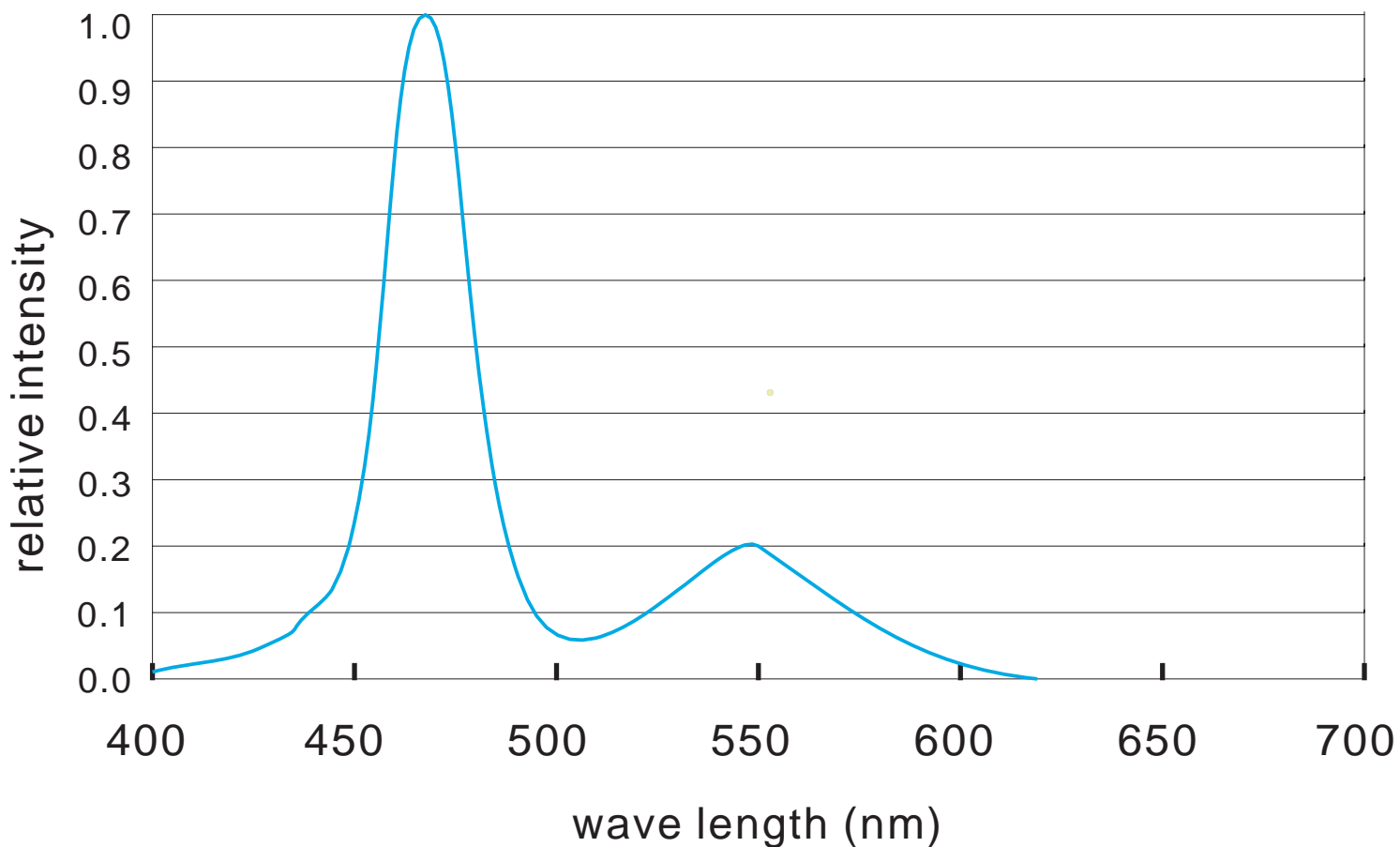

for: white LED

How to connect single color rigid bar

Below shows you how to connect the single color rigid bar to power supplies.

