



Dinam LED Limited, Dynamic lighting for colorful life

PRODUCTS SPECIFICATION

ULTRA-THIN CEILING LIGHT

CL-R20024



Dinam LED Limited

Web: www.dinamled.com

Email: info@dinamled.com

Contact: Luisa

Tel: +86-755-23063529

Fax: +86-755-22700020

Mobile: +86-13600151478

Mobile: +86-13560459594

Address: B Building, Chuangfu Industrial Zone, Beihuan Road,
Shiyuan Town, Baoan District, Shenzhen, China.

LED Ultra-thin ceiling light features

Features:

- Energy saving up to 50%. even lighting output.
- Low voltage: DC 24V.
- Instant start, no flicking, no humming.
- New high efficiency constant current driver.
- Special circuit design, each group of LEDs work separately, avoiding any problem of lighting output caused or influenced by single faulty LED.
- No RF interference.

Photo:



Assembly drawing

Top View

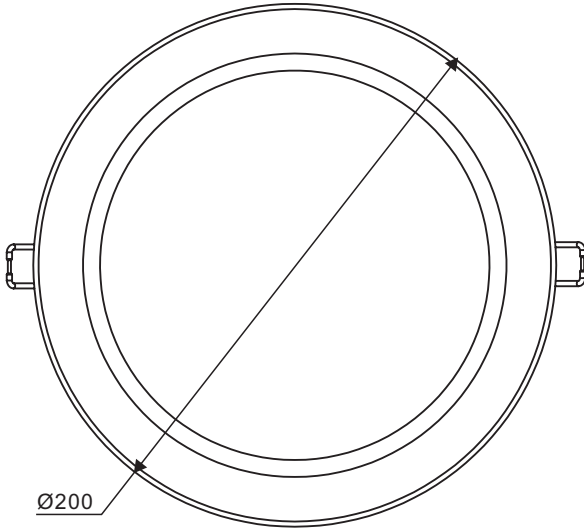

Bottom View

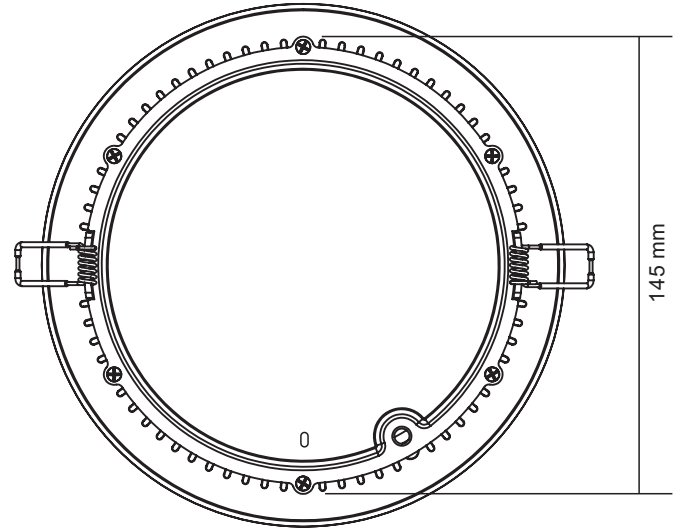

Lateral View

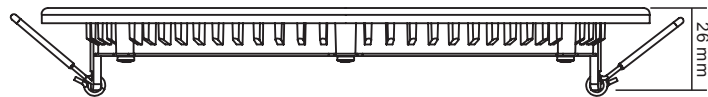

3D View

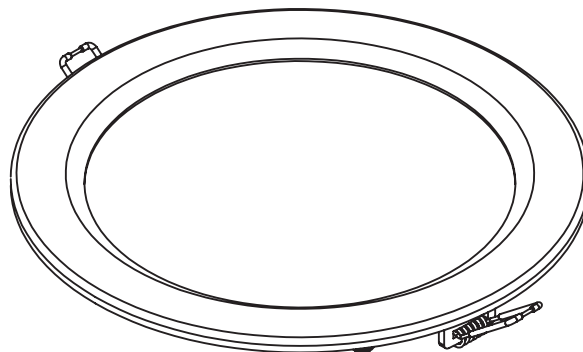

View Angle: 120 degrees

Operation Temperature: $-20\sim 50^{\circ}\text{C}$

Store Temperature: $-30\sim 80^{\circ}\text{C}$

LED Ultra-thin ceiling light features:

SPECIFICATIONS		
NUMBER	ITEM	DESCRIPTION
01	Ceiling light Input voltage	DC 24V
02	LED Type	3528 chip
03	Power consumption	11W
04	luminous flux	600 lm(white) 580 lm(warm white)
05	Color	White Warm white
06	Color temperature	2500~4000k(Warm white) 4000~7000k(White)
07	Life time	>50,000 Hour
08	Operating temperature	-20°C to + 50°C
09	Storage temperature	-30°C to + 60°C
10	Certificates	CE . RoHS
11	Weight	344 G
12	Size	Ø200X26 mm
13	Punch	Ø190mm
14	Water proof	IP20

LED Ultra-thin ceiling light:								
	Ceiling lights: DC 24V							
	Product type	Part number	Color	TC (K)	Lumen	SIZE (MM)	Volt (V)	Power (W)
	Ø 200	CL-R20024-WW	Warm white	2700-4000	600	Φ200 H:26	DC 24V	11 W
CL-R20024-W		Pure white	4000-7000	580				

LED Ultra-thin ceiling light connect:

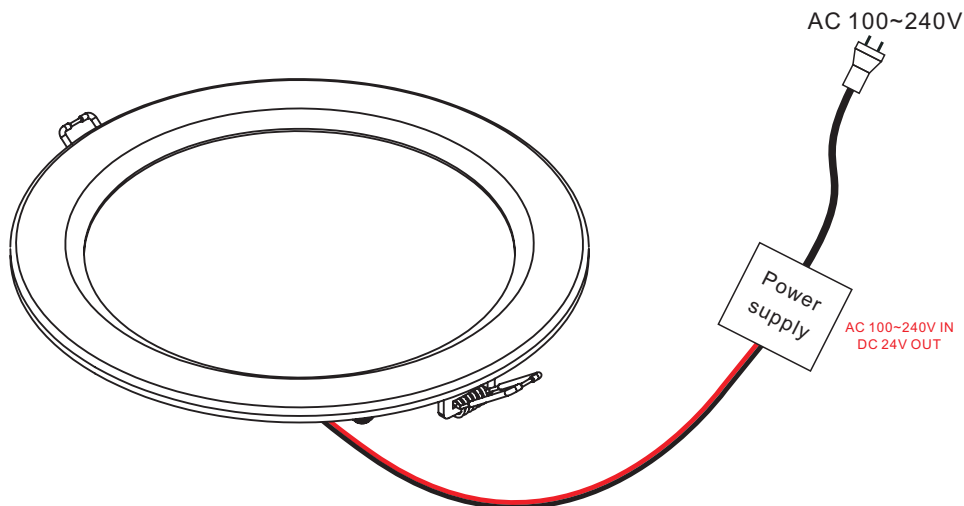

Light Distribution Graph:

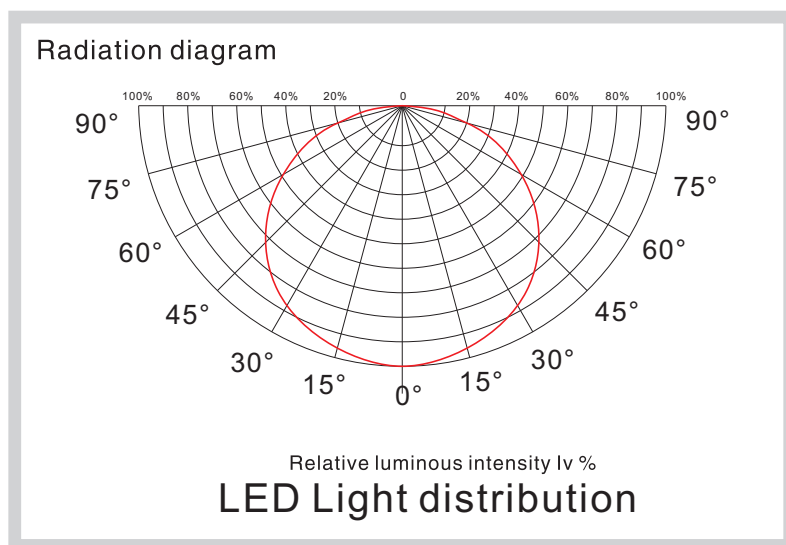

LED Lumen Attenuation:

Operating time(hours)	Lumen decrease(%)
5,000	2.3%
10,000	5.4%
20,000	11.5%
50,000	25.2%